



A款隧道灯/投光灯

www.leihualed.com

深圳市宝安区沙井街道新桥芙蓉工业区芙蓉七路2号安泰和工业大厦12楼F2

- ◆ 50W / 100W / 150W / 200W / 250W / 300W
- ◆ 符合ETL / CE / RoHS / IP65 等认证标准;
- ◆ 明纬电源+Philips / OSRAM / Cree 灯珠;
- ◆ 高光效130lm/W-170lm/W; 进口PC材料透镜,
直照或非对称发光角度, 光线柔和、防眩目、防尘、防水;
- ◆ 6063-T5型材铝散热器,抛光氧化,抗风耐腐,模组式设计;
镂空间隙,借用空气对流,散热效果更加显著;
- ◆ 免维护光衰率低于千分之五, 灯具使用寿命达50000H;
- ◆ 可定制:光控 / 0-10V / DALI智能调光 / 定时调光 / 双色温
应急照明 / 智能PLC无线控制等功能,减少"黑白洞"效应;
- ◆ 3-5年质保.

适用场合:

各种隧道、地下通道、地下涵洞、学校、机场、港口、
码头、体育运动场馆、广场、高速高杆、大型户外、
高架桥、等照明场所;

产品型号	LH-TL-W50A	LH-TL-W100A	LH-TL-W150A	LH-TL-W200A	LH-TL-W250A	LH-TL-W300A
输入功率	50W	100W	150W	200W	250W	300W
输入电压 (V)	100-277VAC					
输入频率	50/60Hz					
功率因数	≥0.95					
电源类型	明纬/飞利浦/英飞特/欧司朗					
电涌保护	4/6KV (可加装20KV)					
灯珠类型	飞利浦/CREE/欧司朗 3030*64pcs	飞利浦/CREE/欧司朗 3030*128pcs	飞利浦/CREE/欧司朗 3030*192pcs	飞利浦/CREE/欧司朗 3030*256pcs	飞利浦/CREE/欧司朗 3030*320pcs	飞利浦/CREE/欧司朗 3030*384pcs
色温	3000-6000K					
显色指数	≥Ra80					
发光角度	30°/ 60°/ 90° T2M T3M T4M					
选装配件	防雷器、应急照明、控制系统、双色温					
灯体材质	6063-T5航空铝					
透镜材质	Pc配光					
IP 等级	IP65					
Ik 等级	IK08					
灯具光效(整灯)	145Lm/W ±10%					
净重	2.50kgs	3.50kgs	5.20kgs	6.50kgs	7.80kgs	11.50kgs
毛重	3.20kgs	4.50kgs	6.50kgs	7.90kgs	9.20kgs	13.50kgs
产品尺寸	85*300*150mm	180*300*150mm	275*300*150mm	370*300*150mm	465*300*150mm	620*275*150mm
包装尺寸	10*33*18cm	21*33*18cm	31*33*18cm	40*33*18cm	50*33*18cm	65*31*18cm

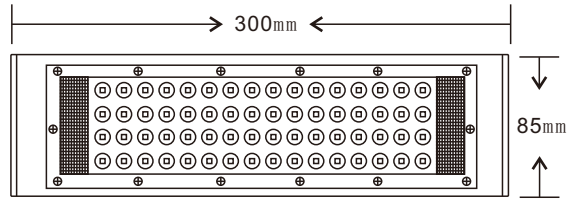

50W

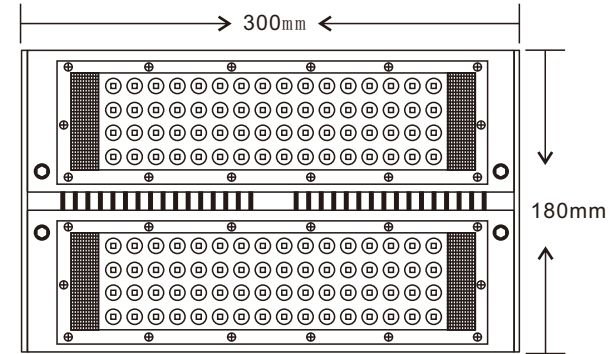
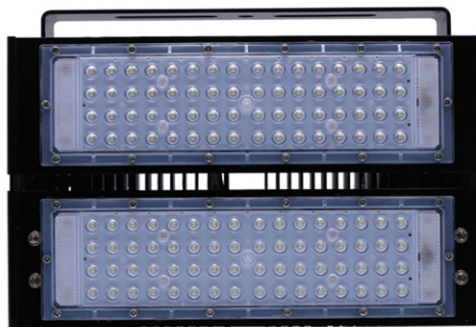

100W

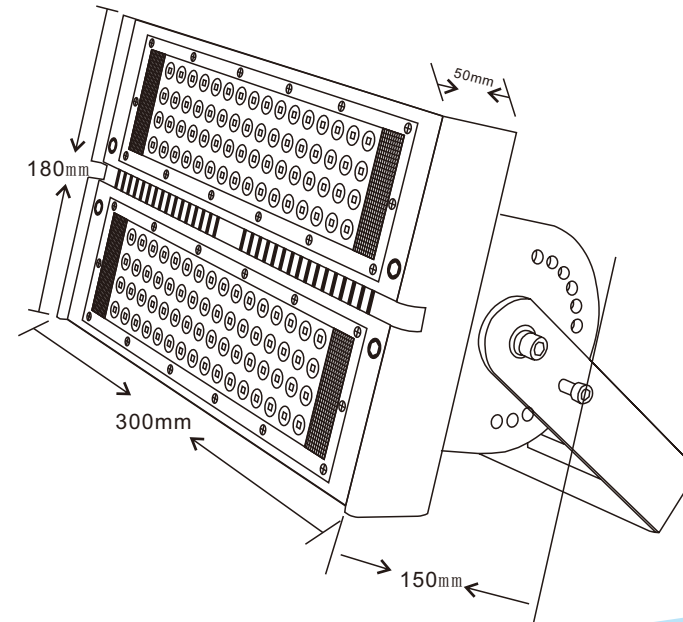

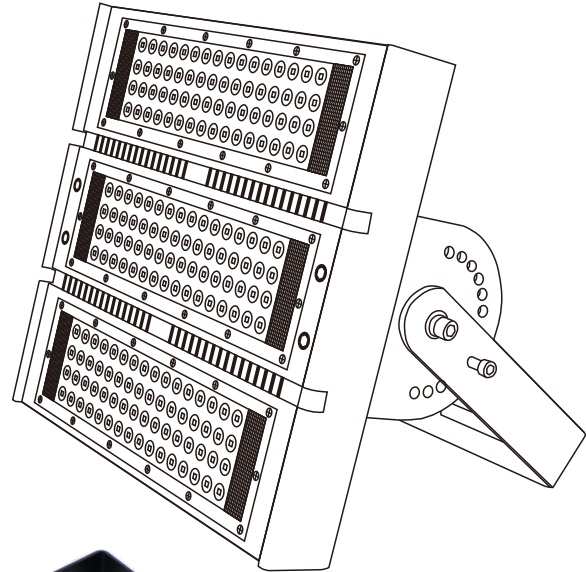
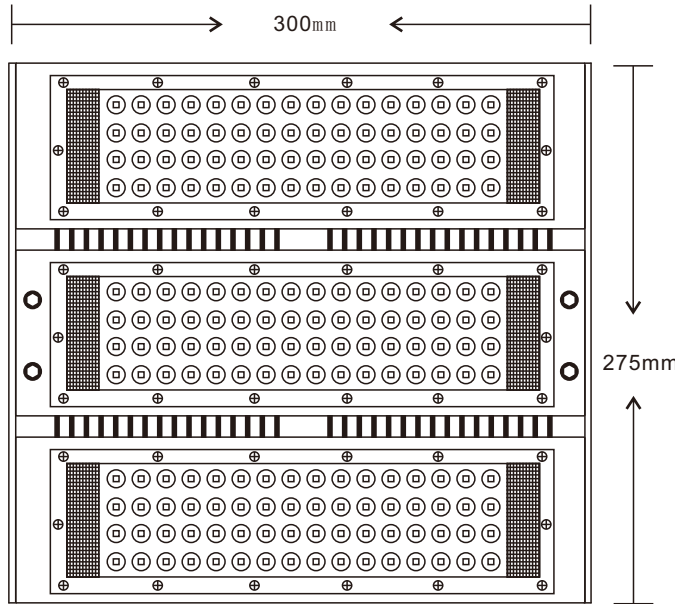

150W



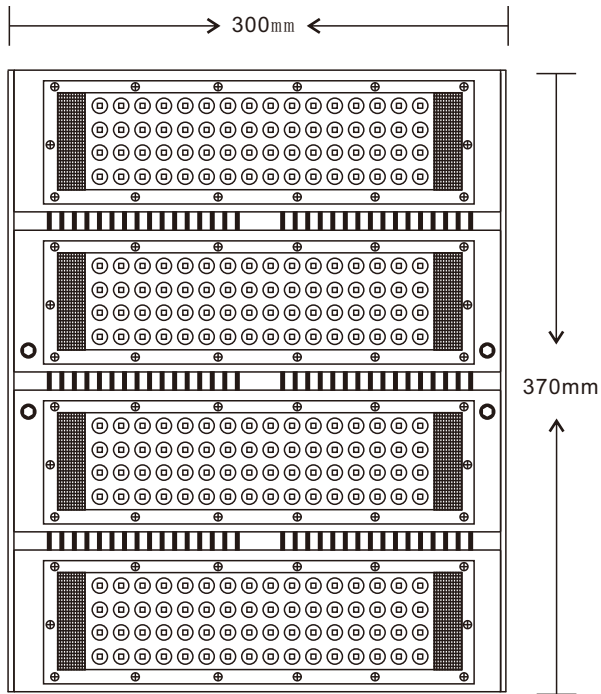

200W

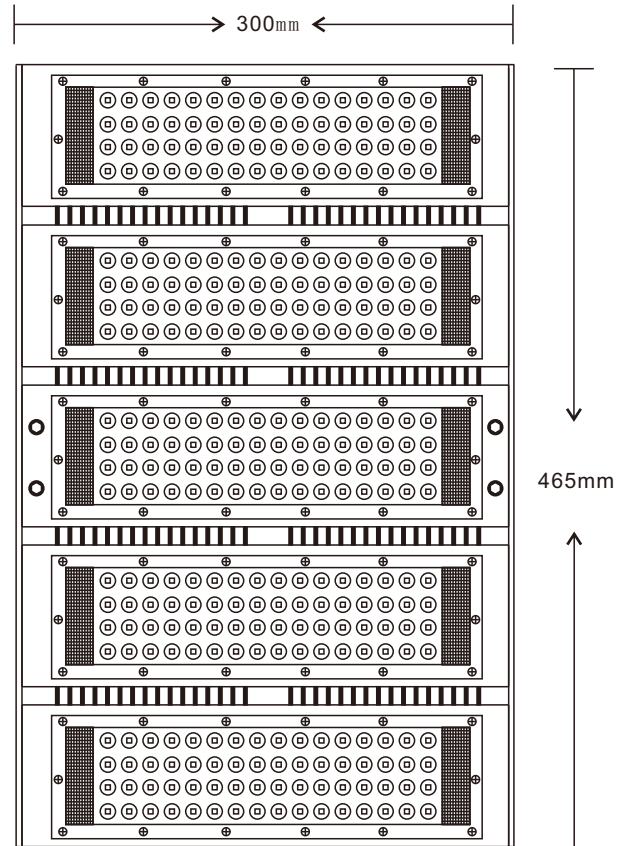
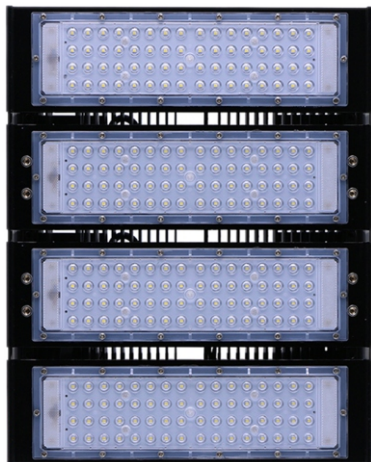

250W

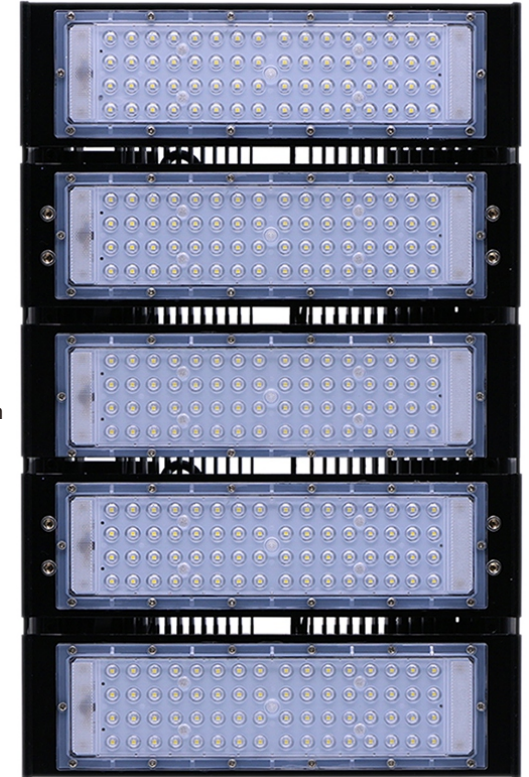

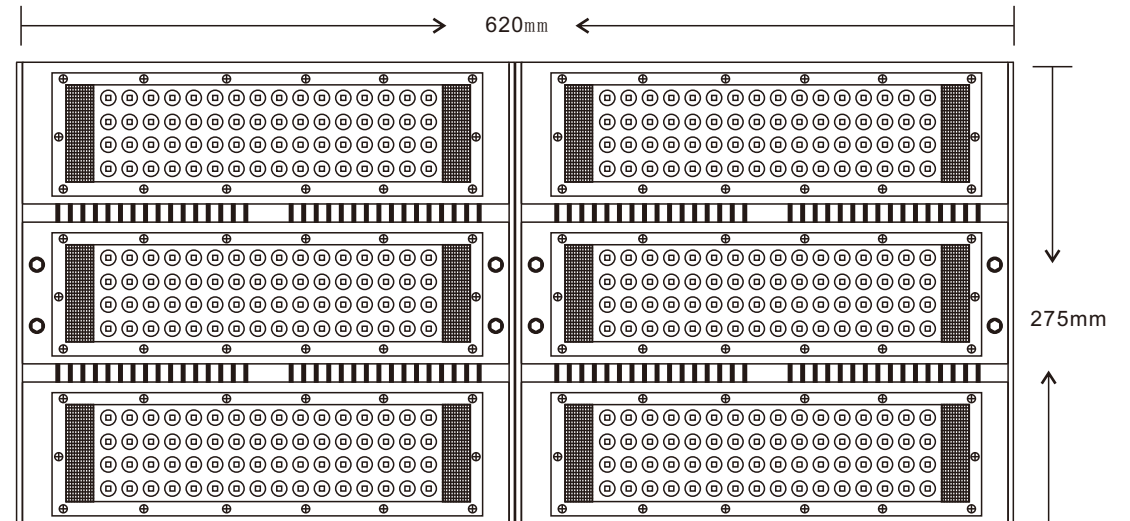
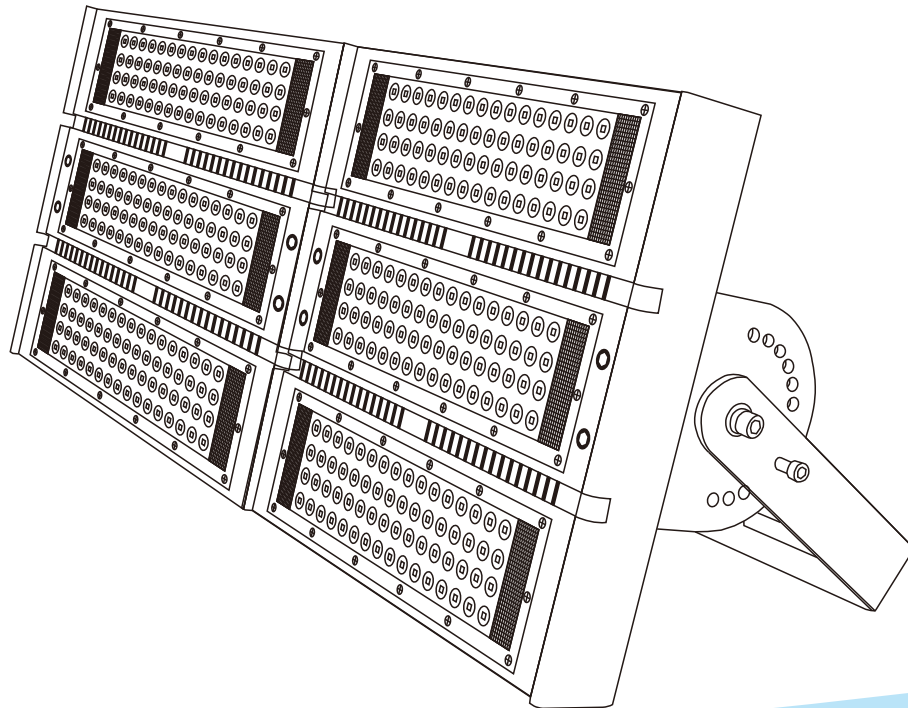
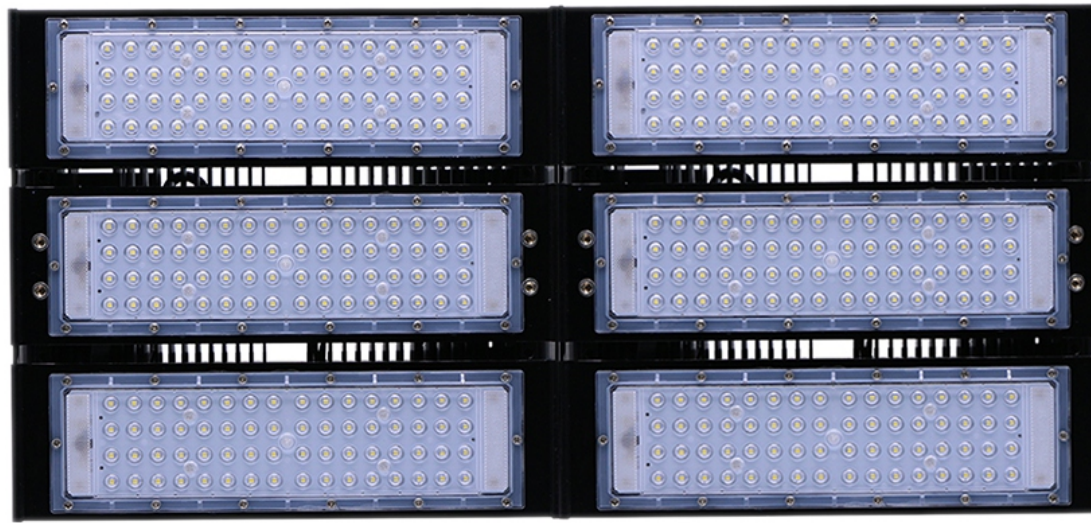

300W